

FLUID COOLING | Industrial AO Series

AIR COOLED AO/AOR

FEATURES

- Young Interchange – OCH
- Adjustable Louvers
- Medium Flow Rates
- Moderate Heat Removal
- One or Two Pass
- Fluid Power Systems
- Gear Drives
- Injection Molding Machines
- Machine Tools
- Torque Converters
- Hydraulic Presses

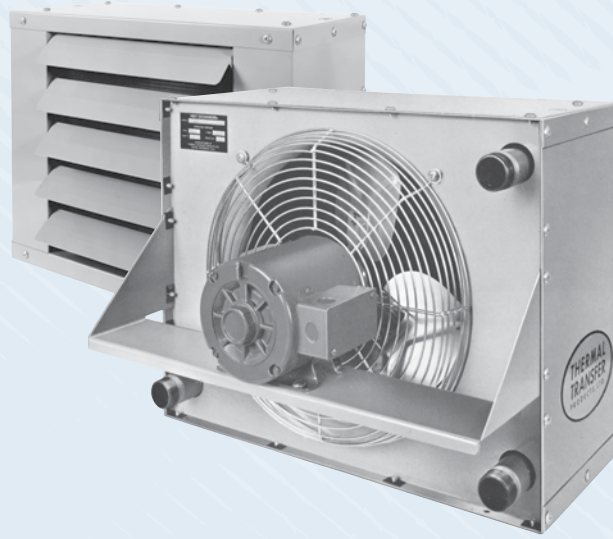

OPTIONS

- SAE & Metric Connections
- Relief Bypass
- Foot Brackets
- Corrosive Resistant
- Marine Coating

Ratings

- Operating Pressure** - 300 psi
- Test Pressure** - 300 psi
- Operating Temperature** - 400° F

Materials

- Tubes** Copper
- Fins** Aluminum
- Turbulators** Steel
- Fan Blade** Aluminum with steel hub
- Fan Guard** Zinc plated steel
- Cabinet** Steel with baked enamel finish
- Manifolds** Steel
- Connections** Steel

Weights

MODEL	Net Weight (LBS)
AO-5	47
AO-10	62
AO-15	72
AO-20	86
AO-25	120
AO-30	135
AO-35	160
AO-40	185

One Pass (Medium to High Oil Flows)

Model Number	Flow Range GPM (USA)
AOR - 5-1	2 - 80
AOR - 10-1	3 - 80
AOR - 15-1	4 - 80
AOR - 20-1	5 - 80
AOR - 25-1	6 - 100
AOR - 30-1	7 - 100
AOR - 35-1	8 - 112
AOR - 40-1	9 - 118

Two Pass (Low to Medium Oil Flows)

Model Number	Flow Range GPM (USA)
AOR - 5-2	2 - 25
AOR - 10-2	2 - 30
AOR - 15-2	2 - 30
AOR - 20-2	2 - 40
AOR - 25-2	2 - 40
AOR - 30-2	2 - 40
AOR - 35-2	3 - 40
AOR - 40-2	4 - 40

One Pass

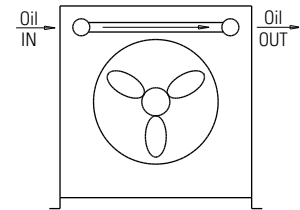

Two Pass

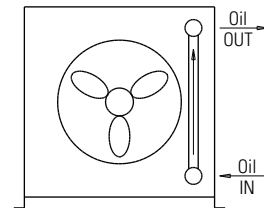

How to Order

Model Series AO	Model Size Selected	Number of Passes* Blank - No Bypass 1 - One Pass 2 - Two Pass	Connection Type Blank - NPT S - SAE M - Metric	Relief Bypass Setting* 30-30 psi 60 - 60 psi	Foot Mounted Brackets Blank - No Brackets FB - Foot Brackets	Specify Motor Required Single Phase Single Phase Expl. Proof Three Phase Three Phase 575 Volt Three Phase Expl. Proof

*ADD FOR AOR MODELS ONLY: Relief Bypass Setting & Number of Passes

Specifications

Electric motor & Fan data*

Model	CFM	Sound dB(A)** at 7 ft.	Horse Power	Volts	Phase	Full Load Amps	Hz	Nema Frame	RPM	Type	Circuit	Thermal Overload	Bearing B-Bal S-Sleeve
A0-5	401/487 494	68 70	1/12 1/4	110/115 208-230/460	1 3	1.2/1.2 1.4-1.3/.65	50/60 60	48	1400/1700 1725	TEAO TEFC	A D	No	B
A0-10	576/700 710	68 70	1/12 1/4	110/115 208-230/460	1 3	1.2/1.2 1.4-1.3/.65	50/60 60	48	1400/1700 1725	TEAO TEFC	A D	No	B
A0-15	824/1000 1015	69 71	1/12 1/4	110/115 208-230/460	1 3	1.2/1.2 1.4-1.3/.65	50/60 60	48	1400/1700 1725	TEAO TEFC	A D	No	B
A0-20	1555	70 72	1/6 1/4	115/208-230 208-230/460	1 3	4/2.1-2 1.4-1.3/.65	60 60	48	1725	TEFC TEFC	C D	No	B
A0-25	2240	72 73	1/6	115/208-230 208-230/460	1 3	4.6/2.2 1.3-1.2/.6	60	48	1140	TEFC	C D	No	B
A0-30	3100	75 76	1/6	115/208-230 208-230/460	1 3	5.2/2.7-2.6 1.3-1.2/.6	60	48	1140	TEFC	C D	No	B
A0-35	4370	76 77	1/2	115/208-230 208-230/460	1 3	8/4.2-4 2.5-2.4/1.2	60	56	1140	TEFC	C D	No	B
A0-40	5450	78 79	1/2	115/208-230 208-230/460	1 3	8/4.2-4 2.5-2.4/1.2	60	56	1140	TEFC	C D	No	B

*Published electrical ratings are approximate, and may vary because of motor brand. Actual ratings are on motor nameplate.

**Catalog dB(A) sound levels are at seven (7) feet. dB(A) sound levels increase by six (6) dB(A) for halving this distance and decrease by six (6) dB(A) for doubling this distance.

Explosion Proof Motors (Class I GP.D & Class II GP.F, G)*

Model	CFM	Sound dB(A)** at 7 ft.	Horse Power	Volts	Phase	Full Load Amps	Hz	Nema Frame	RPM	Type	Circuit	Thermal Overload	Bearing B-Bal S-Sleeve
A0-5	494	68 70	1/4	115/230 208-230/460	1 3	5.8/2.9 1.4-1.3/.65	60	48	1725	FC	C D	Yes	B
A0-10	710	68 70	1/4	115/230 208-230/460	1 3	5.8/2.9 1.4-1.3/.65	60	48	1725	FC	C D	Yes	B
A0-15	1015	69 71	1/4	115/230 208-230/460	1 3	5.8/2.9 1.4-1.3/.65	60	48	1725	FC	C D	Yes	B
A0-20	1555	70 72	1/4	115/230 208-230/460	1 3	5.8/2.9 1.4-1.3/.65	60	48	1725	FC	C D	Yes	B
A0-25	2240	72 73	1/3	115/230 208-230/460	1 3	6.8/3.4 1.8-1.6/.8	60	56	1140	FC	C D	Yes	B
A0-30	3100	75 76	1/3	115/230 208-230/460	1 3	6.8/3.4 1.8-1.6/.8	60	56	1140	FC	C D	Yes	B
A0-35	4370	76 77	1/2	115/230 208-230/460	1 3	8/4 2.5-2.4/1.2	60	56	1140	FC	C D	Yes	B
A0-40	5450	78 79	1/2	115/230 208-230/460	1 3	8/4 2.5-2.4/1.2	60	56	1140	FC	C D	Yes	B

*Published electrical ratings are approximate, and may vary because of motor brand. Actual ratings are on motor nameplate.

575 Volt

Model	CFM	Sound dB(A)** at 7 ft.	Horse Power	Volts	Phase	Full Load Amps	Hz	Nema Frame	RPM	Type	Circuit	Thermal Overload	Bearing B-Bal S-Sleeve
A0-5	494	70	1/4	575	3	.52	60	48	1725	TEFC	D	No	B
A0-10	710	70	1/4	575	3	.52	60	48	1725	TEFC	D	No	B
A0-15	1015	71	1/4	575	3	.52	60	48	1725	TEFC	D	No	B
A0-20	1555	72	1/4	575	3	.52	60	48	1725	TEFC	D	No	B
A0-25	2240	73	1/2	575	3	.88	60	56	1140	TEFC	D	No	B
A0-30	3100	76	1/2	575	3	.88	60	56	1140	TEFC	D	No	B
A0-35	4370	77	1/2	575	3	.88	60	56	1140	TEFC	D	No	B
A0-40	5450	79	1/2	575	3	.88	60	56	1140	TEFC	D	No	B

*D Squirrel Cage

**Catalog dB(A) sound levels at seven (7) feet. dB(A) sound levels increase by six (6) dB(A) for halving this distance, and decrease by six (6) dB(A) for doubling this distance.

Lubrication Notes

Caution: Do not over oil or over grease. **Ball bearings** – No grease needed at start up. Grease as follows:

5,000 Hours/Year	5 Year Grease Interval
Continuous Normal Applications	2 Years
Seasonal Service Motor is idle for 6 months or more	1 Year
Continuous High ambients, dirty or moist locations, high vibration	6 Months

Dimensions

Model	A	B	C	D	E	F	G	H	J	K	L	M NPT	M SAE	N	P	T
AO-5	7.40	14.81	5.90	11.81	20.00	9.19	8.31	6.47	12.94	3.78	7.56	1"	#16 SAE	5.84	11.69	—
AO-10	9.50	19.00	6.56	13.12	19.25	10.50	12.50	8.56	17.12	4.44	8.88	1"		1-5/16-12UN-2B	7.94	15.88
AO-15	10.19	20.38	7.87	15.75	19.25	13.12	13.88	9.25	18.50	5.75	11.50	1"	Thread	8.62	17.25	—
AO-20	11.91	23.81	9.19	18.38	19.25	15.75	17.91	10.90	21.81	7.00	14.00	1-1/4"	#20 SAE	10.28	20.56	—
AO-25	13.34	26.68	11.81	23.62	19.25	21.00	20.19	12.40	24.81	9.62	19.25	1-1/4"		1-5/8-12UN-2B	11.78	23.56
AO-30	15.81	31.62	13.78	27.56	19.50	24.94	25.12	14.87	29.75	11.59	23.19	1-1/4"	Thread	14.25	28.50	11.00
AO-35	16.90	33.81	15.09	30.19	21.50	27.56	27.31	15.97	31.94	12.90	25.81	1-1/4"		15.34	30.69	11.00
AO-40	20.81	41.62	18.37	36.75	20.50	34.12	35.12	19.87	39.75	16.19	32.38	1-1/4"		19.25	38.50	13.25

NOTE: All dimensions in inches.

Installation Piping Diagram

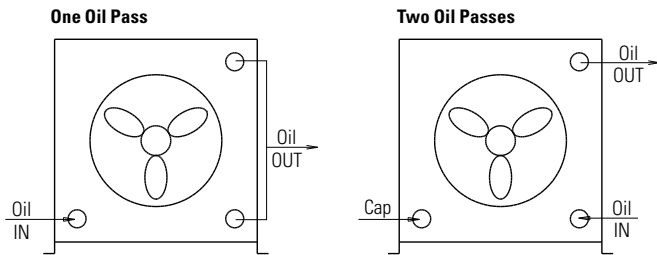

*See dimension chart for NPT or optional internal SAE connection size.

Fan Rotation Clockwise/Facing Motor Shaft

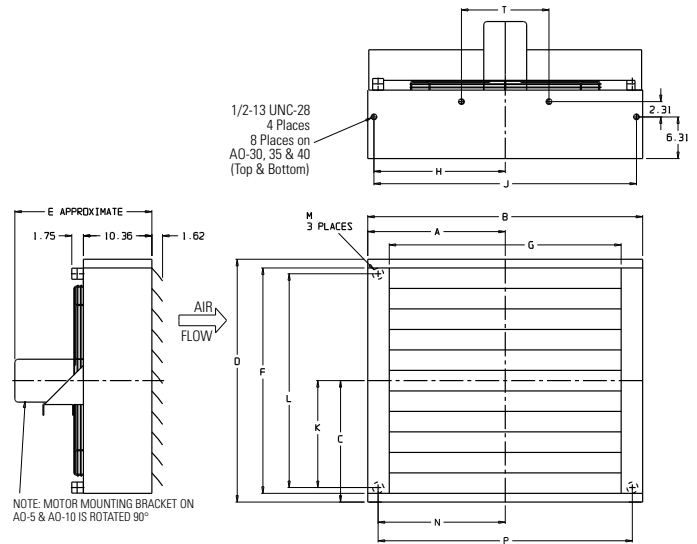

C_v Viscosity Correction

Average Oil Temp °F	OIL					
	SAE 5 110 SSU at 100°F 40 SSU at 210°F	SAE 10 150 SSU at 100°F 43 SSU at 210°F	SAE 20 275 SSU at 100°F 50 SSU at 210°F	SAE 30 500 SSU at 100°F 65 SSU at 210°F	SAE 40 750 SSU at 100°F 75 SSU at 210°F	50-50 Ethylene Glycol & Water
100	1.14	1.22	1.35	1.58	1.77	1.11
150	1.01	1.05	1.11	1.21	1.31	1.02
200	.99	1.00	1.01	1.08	1.10	.96
250	.95	.98	.99	1.00	1.00	.95

Performance Curves

One Pass Oil

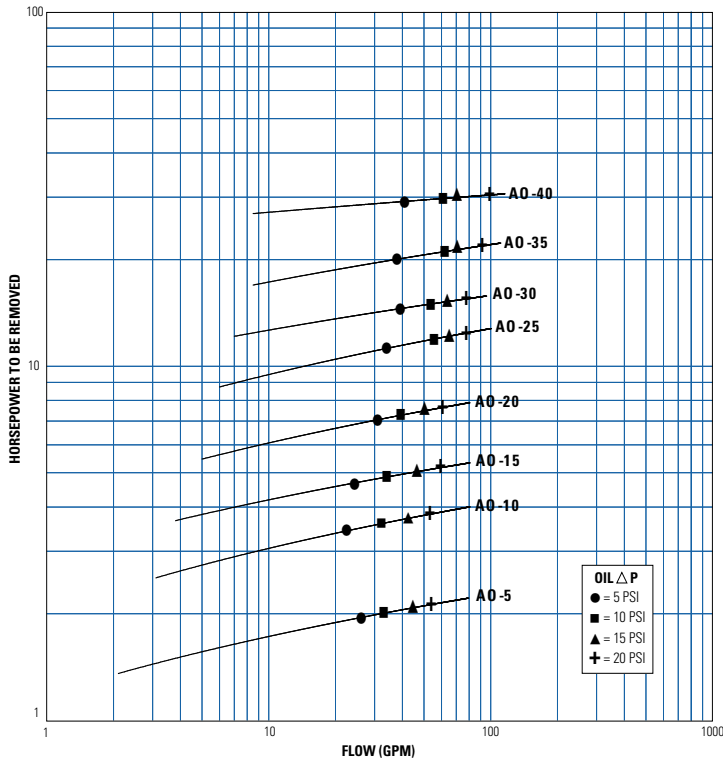

Two Pass Oil

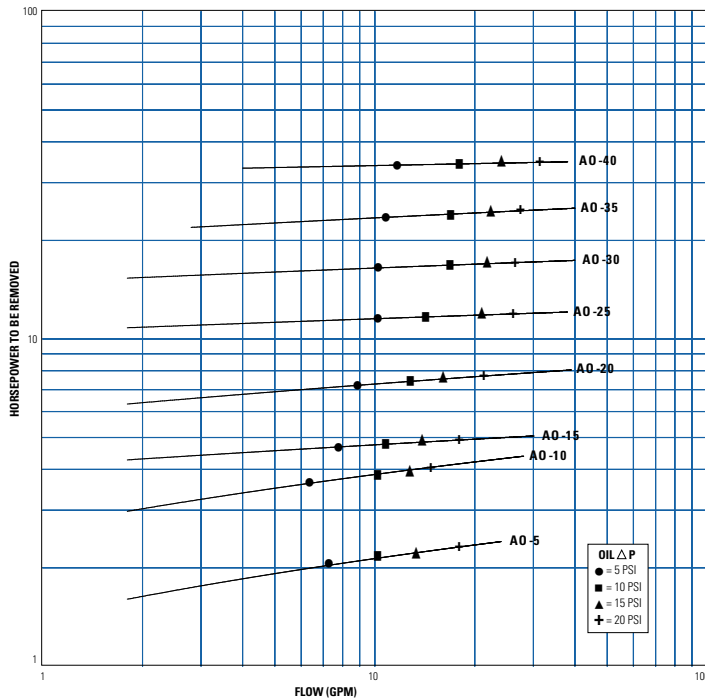

Selection Procedure

Performance Curves are based on 50SSU oil leaving the cooler 40°F higher than the ambient air temperature used for cooling. This is also referred to as a 40°F approach temperature.

STEP 1 Determine the Heat Load. This will vary with different systems, but typically coolers are sized to remove 25 to 50% of the input nameplate horsepower.

(Example: 100 HP Power Unit x .33 = 33 HP Heat load.)

$$\text{If BTU/Hr. is known: } \text{HP} = \frac{\text{BTU/Hr}}{2545}$$

STEP 2 Determine Approach Temperature. Desired oil leaving cooler °F – Ambient air temp. °F = Actual Approach

STEP 3 Determine Curve Horsepower Heat Load. Enter the information from above:

$$\text{Horsepower heat load} \times \frac{40 \times \text{Cv}}{\text{Actual Approach}} = \text{Curve Horsepower}$$

STEP 4 Enter curves at oil flow through cooler and curve horsepower. Any curve above the intersecting point will work.

STEP 5 Determine Oil Pressure Drop from Curves:

● = 5 PSI; ■ = 10 PSI; ▲ = 14 PSI; + = 20 PSI. Multiply pressure drop from curve by correction factor found in oil Δ P correction curve.

Desired Reservoir Temperature

Return Line Cooling: Desired temperature is the oil temperature leaving the cooler. This will be the same temperature that will be found in the reservoir.

Off-Line Recirculation Cooling Loop: Desired temperature is the oil temperature entering the cooler. In this case, the oil temperature change must be determined so that the actual oil leaving temperature can be found. Calculate the oil temperature change (oil Δ T) with this formula:

$$\text{Oil } \Delta T = (\text{BTU's/Hr.}) / (\text{GPM Oil Flow} \times 210)$$

To calculate the oil leaving temperature from the cooler, use this formula:
 Oil Leaving Temp. = Oil Entering Temp – Oil Δ T.

This formula may also be used in any application where the only temperature available is the entering oil temperature.

Oil Pressure Drop: Most systems can tolerate a pressure drop through the heat exchanger of 20 to 30 PSI. Excessive pressure drop should be avoided. Care should be taken to limit pressure drop to 5 PSI or less for case drain applications where high back pressure may damage the pump shaft seals.

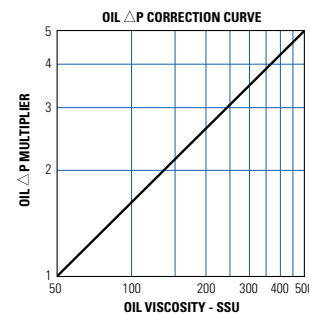

Oil Temperature

Typical operating temperature ranges are:

Hydraulic Motor Oil	110° - 130°F
Hydrostatic Drive Oil	130° - 180°F
Bearing Lube Oil	120° - 160°F
Lube Oil Circuits	110° - 130°F